



# Surveillance Security Camera Guide



By

Guy Avital

DVRMASTER.COM

All Rights Reserved

---

# A BUYERS GUIDE TO SURVEILLANCE SECURITY CAMERA SYSTEMS

There are a variety range of security cameras, security DVR and prices to choose from in the surveillance security camera market, we will provide you with information to make the right choice between them. We hope this security camera guide will help you learn more about selecting a CCTV security camera system. If you have any queries please call us at **888-925-3235** for expert advice.

## **Wired CCTV**

Wired security cameras provide zero interference and can be installed hundreds of feet away from the security DVR System (monitoring/recording equipment). Usually with wired security cameras you do not have to power the camera locally. One cable called Siamese will take both power and video signal back to the recording device and the power supply.. Go to [Wired CCTV Cameras](#) to see our full range.

There are many of professional Security surveillance installers who will give you a site survey and recommend appropriate products but, of course, your price is going to be higher for the service. Today technology has now made CCTV products much more affordable and easy to install and they can be very easy to fit for the average person. This guide will help you choose the correct products and

---

---

## Wireless CCTV

Very popular lately is wireless transmission. Today an average wireless kit can transmit video and audio up to 1600ft. This reduces to approximately 40-50% when used indoors. These Simple wireless cameras will only work on 4 channel frequency so you cannot use more than 4 of these kits next to each other. Cameras and receivers are available with 4 selectable channels making multi-camera systems feasible.

Even the small covert type of camera can be supplied with its own built-in transmitter. Go [Wireless Cameras kits](#) to see our full range of covert wireless cameras.

Remember that CCTV security cameras require power to operate. The voltage is usually in the range 12V to 24V. Wireless transmission is also useful for temporary monitoring of an office or reception area.

## Cameras

The standard traditional CCTV security camera has a very industrial bulky style and, therefore, many people would not find this suitable for homes and esthetics office area. These box types of cameras are usually specified without a lens, this being chosen to give the required focal length and field of view. Which give you the advantage to chose the right lens for the application,

Integrated security cameras and lenses are usually called bullet or IR camera they have a sealed to prevent ingress of moisture. The sealing is so good that they are water and weather proof. Integrated cameras do not need a heater and their small size makes them highly suitable for fitting to domestic and commercial properties. Some of these cameras come with vari focal of 4 to 9 mm lens which let you adjust to a desire picture while enjoying it small size and water resistant.

Many of our built-in lens cameras are fitted with a 3.6mm lens which gives a 72deg angle of view which is suitable for most domestic and small business.

---

## Camera Specification Guide



Here will try to explain how to read camera spec and understand their effect on the performance of the camera in the environment. Understanding camera spec will let you make wise decision on selecting the right camera for your environment cameras. All the cameras listed meet and exceed the minimum standards for professional surveillance applications. A lot of this information is good to review but you really do not need to memorize it.

### CCTV Camera Resolution (Picture Quality)

All cameras performance and picture quality is based on the number of horizontal lines the chip in the camera provides. Called the lines of resolution or TVL which specified the quality of the video the camera can produce. The higher the TV lines of resolution are, the better the quality of the image the camera send to the DVR.

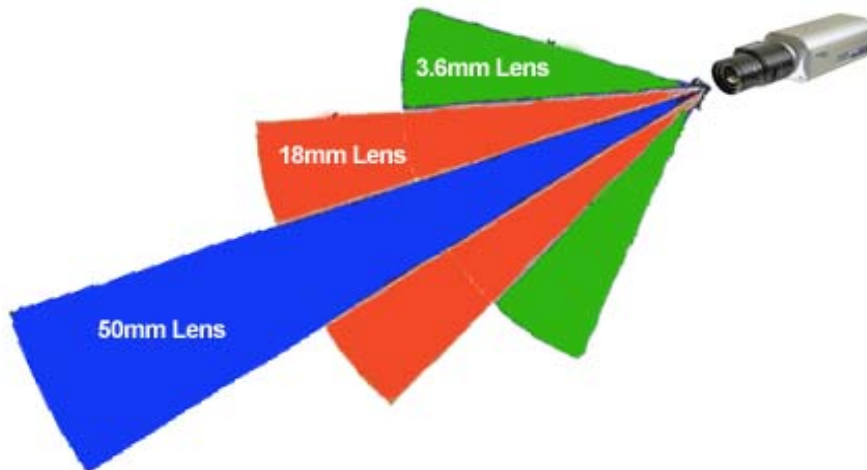
Standard Image Quality	380TVL To 420TVL
High Image quality	420TVL To 480TVL
Very High Image Quality	480 TVL to 570TVL



3.6mm	12mm	18mm
		

### **Color or Black white Security Camera?**

Our eyes can see and recall things better if they appear in color - it's easier to track down a blond-haired person wearing a green sweater and black jeans than a dark, grey-black figure that would be produced in a black and White camera

Color security cameras carry an additional premium in price compared with black and white cameras. But they are also less sensitive to light and makes it an impractical option unless good lighting is available. Black and white B/W security cameras have better resolution and clear pictures in low light conditions. All infrared security cameras turn to black and white during low light conditions and résumé to color in good light conditions. This can be particularly useful where planning permission makes extra lighting impractical or the security requirement is such that intruders should not be alerted to the existence of CCTV surveillance.

Day and night cameras are a fairly new technology. These types of cameras can operate in full color and have a sensor that switches to black and white camera when the light condition is lower than 1.5 lux

### **Indoor/outdoor cameras**

If a camera is to be installed outside and is not going to be mounted in a camera housing, it must be classified as weather resistant or IP 66. All of our outdoor cameras are fully weatherproof. The cable entry points are sealed and most cameras come with trailing leads that allows the connections to be made inside the building.

---

## **Light levels**

Selecting the correct security camera to operate in the right light conditions is possibly one of the most important although most tricky to understand.

Light levels are usually measured in Lux. This is a measure of the light energy arriving on an area 1m<sup>2</sup> of surface per second.

Typical light levels are:

Full Sunlight: 50,000 Lux

Dull Daylight: 10,000 Lux

Shop/Office environment: 500 Lux

Dawn/Dusk: 1 - 10 Lux

Side Street Lighting: 0.5 - 3 Lux

Total Darkness 0 Lux

The rule of thumb when deciding which security camera to use for a given lighting condition is not to choose one that will only just give a picture. Try to give the camera approximately 10 times its quoted minimum scene illumination. The biggest problem is when they do not have enough light to produce a picture.

A B/W security camera rated at 0.05 Lux will produce reasonable results. Color security camera needs a little more usually more than 1 Lux. ,But color cameras achieve good night-time vision by switching to a B/W mode (Day&Night cameras). You will never get good night-time color pictures without additional lighting.

## **Resolution**

The value referred to here is the horizontal resolution in TV lines, that is the number of black to white transitions that can be resolved across the image. This is a function of the number of pixels that make up the CCD imaging area and the bandwidth of the camera circuitry. Typical entry level camera resolution is 330 TV lines, with high resolution cameras producing better than 580 lines.

---

## The Lens (Optics)

Lenses (Optics) play an important role in the design of a CCTV system. Their primary function is to collect reflected light from a scene and focus a clear, sharp image on the camera's imager. Typically, the more light that passes through a lens, the better the quality of the picture.

Selection of a lens is especially critical because it directly affects the size, shape, and sharpness of the image to be displayed on the imager. Factors such as distance from the scene, focal length, desired field of view, lighting and format affect the size and clarity of the image on the camera's imager.

## Field of View

The field of view (FOV) is the actual picture size (height and width) produced by a specific lens. If the field of view is not suitable, you may consider using a different lens (wide angle, telephoto, etc.) to increase or decrease the field of view. Tables are available to calculate the proper imager size, lens and distance combination needed to produce a desired field of view. See page 92 of this catalog.

Camera lenses can be divided into two basic types: fixed focal and varifocal (or zoom). A fixed focal lens has a constant focal length, while a varifocal lens can change its focal length. Focal length is simply the distance from the optical center of the lens to a focal point near the back of the lens. This distance is written on the lens (in millimeters) and indicates the field of view produced by the lens (See figure 7)

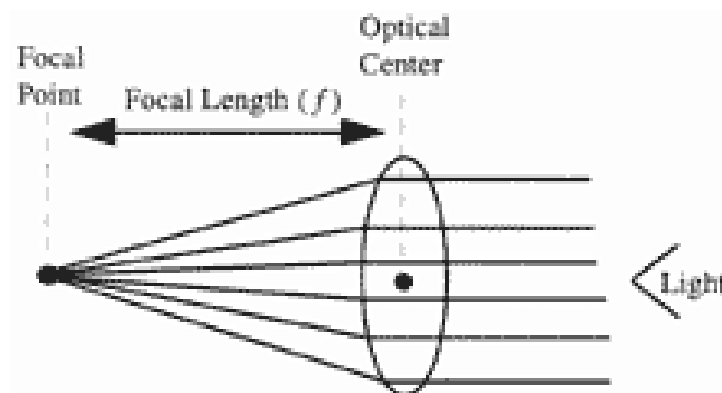

Figure 7: Focal length

Fixed focal length lenses are available in various wide, medium, and narrow fields of view. A lens with a "normal" focal length (Ex: 8.0mm on a 1/3" camera) produces a picture that approximates the field of view produced by the human eye. A wide-angle lens has a short focal length, while a telephoto lens has a long focal length (See figure 8). When you select a fixed lens for a particular field of view, bear in mind that if you want to change the field of view, you must change the lens.

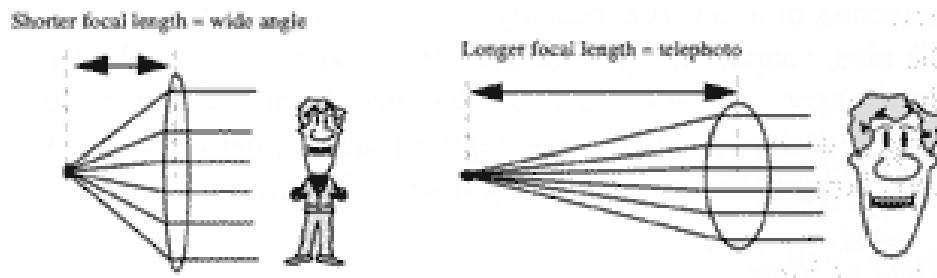

Figure 8: Wide angle vs. telephoto.

When both wide scenes and close-up views are needed, a varifocal or zoom lens is best. A zoom lens is an assembly of lens elements that move to change the focal length from a wide angle to telephoto while maintaining focus on the camera's imager. This permits you to change the field of view between narrow, medium, and wide angles, all on one lens.

#### F-Stop

The ability of a lens to gather light depends on the relationship between the lens opening (aperture) and the focal length.

This relationship is symbolized by the letter  $f$ , which is commonly referred to as the "F-stop," and can be found printed on the side or front of the lens (see figure 9). The lower the F-stop number, the larger the maximum lens aperture and the greater the lens' ability to pass light through to the camera's imager.

For example, a lens with an F-stop of  $f/1.2$  can gather a great deal more light than a lens with an F-stop of  $f/4.0$ . A lens with a low F-stop number is called a "fast" lens

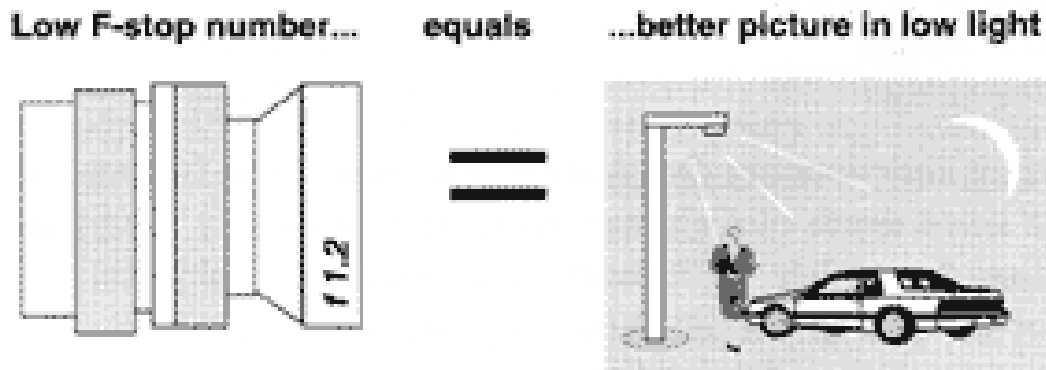
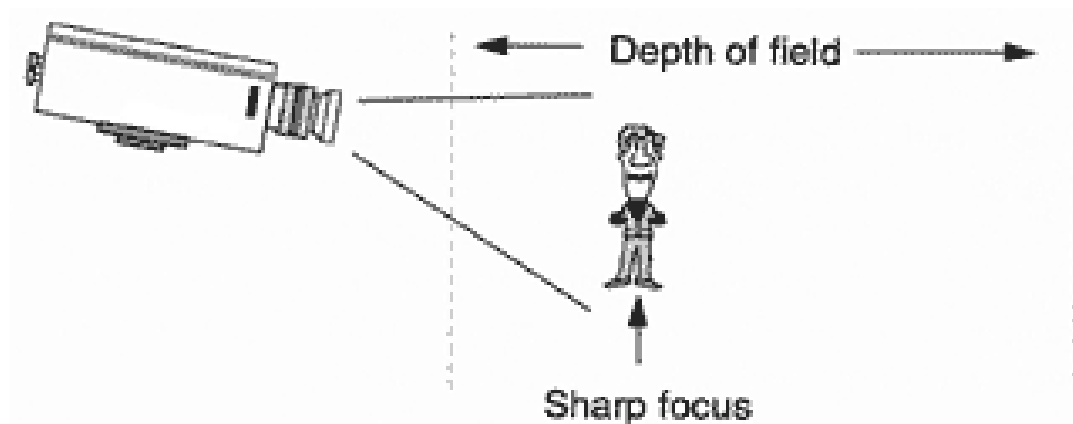

Figure 9: The F-stop indicates the lens' light gathering ability.

### Depth of Field

Another consideration when determining the proper lens is depth of field. Depth of field is the area in focus before and behind a subject (see figure 10). This means that when you focus precisely on a subject, a certain distance in front of and behind the subject also will be in focus, although not as sharp. Depth of field increases or decreases based on the 1.) Length of the lens, 2.) The lens aperture and 3.) Distance from the camera to the subject.



- 
- 1) Lens length    Short lens (i.e. wide angle)  
    = longer depth of field
  - 1) Lens length    Long lens (i.e. telephoto)      = shorter depth of field
  - 2) Aperture      Wide aperture (low F-stop)  
    = shorter depth of field
  - 2) Aperture      Narrow aperture (high F-stop)      = longer depth of field
  - 3) Distance to subject    Short distance  
    = shorter depth of field
  - 3) Distance to subject    Long distance      = longer depth of field

Purchasing and planning decisions should take these factors into account since depth of field can affect image quality (and may jeopardize the ability to identify and prosecute subjects). If depth of field is important, you may want to explore options such as increasing artificial lighting or installing cameras with normal lenses rather than telephoto lenses, etc.

---

## Recording Surveillance CCTV or Security Camera Images

### Security DVR System.

#### Triplex DVR

Triplex DVR- capable of performing all three functions at the same time that is simultaneous recording, playback and Viewing of cameras and a multi-screen display with both live and playback images). This allows the operator to keep monitoring the site while playback.



## PC based DVR?

PC-based DVR is a DVR Cards built inside a computer. You have a case either a tower or a rack mount. Inside you have your usual motherboard, Network card, VGA Card CPU, Hard Drive and memory. And inside is a PCI DVR Card. This capture board have 4,8,16 video input. The PC Based system receive the analog signal from all the cameras, it convert the signal to digital signal and compress it with mp4 compression, and than it store the data on the hard drive for archiving and playback. The DVR software provides all the necessary, video and recording functions: like, Video compression, converting the video to a file, camera controls and display, record and playback functions.

PC based DVR provide far better video recording clarity over Time Lapse and are easier to use and more flexible than standalone DVR's. These units are available as kits which you install on your PC or as complete factory built recorders and provide you with all the functionality you need for your Surveillance system. Some factory models can be expanded as your needs grow, this is not the case with Time Lapse or standalone (Hardware) DVR's.

PC Based DVR work on a computer base system so you can customize the hardware spec for you need ,like Size of hard drive or Multiple Hard drive, memory and processor. Etc...

PC Based DVR available in:



Our PC Based DVR system built mostly on dell system which provides you with reliability and warranty. With high performance DVR system and full support before and after you buy from us. The Surveillance system you get from DVRMaster comes preconfigured, Plug-N-Play, so the only thing you need to do is run the cable, connect to the DVR and you are ready to go.

Go to our [Digital Video Recorders ..](#)

---

## **Standalone, Surveillance DVR System.**

Standalone DVR System is a perfect DVR solution for those PC-phobic clients. Every function on this DVR is a matter of a push of a button. Stand alone DVR has off-site viewing function that allows you to view from anywhere in the world. This is all with digital quality. With two or more internal hard-drive spaces and two external hard-drive connections, Standalone DVR recording time can extend at your preference.

Standalone DVR are computer base Machine which run on Linux, Unix or other proprietary Operating system that was design to run only one application, which makes the standalone Device a reliable appliance and does one thing only. Because of that, standalone DVR are more reliable but limited in the functionality and upgrades.

Standalone Digital Video Recorder Overview

Benefits:

- High Resolution Recordings (720x480)
  - Easy to use and operates
  - Fax function usually one button operation
  - Very stable and very low maintenance
  - Stores large amounts of video or recording days
- Easy network integration

### **Limitations:**

- The system runs on a proprietary operation system, which make it not flexible to standard changes or upgrades
- users must have average computer skills



- Real Time Display
- 16 Channel Video and Audio
  - 4 Channel Audio
  - 120Fps Recording
- Embedded Linux Operation Systems for Reliability
- Triplex Function (Record / Playback / Remote View)
  - MPEG-4 Compression
  - allows : Live Monitoring,

---

## **Other Digital CCTV Systems**

Other digital products on the market allow remote viewing and recording via internet connection or telephone network. Advances in compression technology allow excellent quality recording and remote viewing putting the old style? web casting? Methods firmly in the past.

## **Motion Detectors**

DVR Motion detection is the modern alternative to the PIR. It works by analyzing the video frames coming from the camera. The DVR analyze frame by frame and when it detect change in the frame which apply on movement it will start recording and by recording data in the cache and continue recording for interval time after the movement stops. When it detects changes in the signal it recognizes this as movement within the camera\'s picture the output being used to switch on the recording device. The sensitivity can be adjusted which will overcome the problem of bright lights being turned on causing the Motion detection to activate.

The more sophisticated units feature an on-screen marker or rectangle. Only movement in the rectangle will trigger the output. By resizing and repositioning the rectangles it is possible to allow for pet activity within the observation area. In the example the blue car turning into the drive will activate the recorder but the grey car passing on the road will not.

Most digital and PC-based and standalone DVR systems have motion detection built in to them. This can make multi-camera digital systems very cost effective as it alleviates the need to buy motion detectors for each camera or observation area

## **CCTV Signal**

Selecting the correct cable/ media for security camera application (CCTV) is one of the most important aspects of designing and implementing a quality security DVR system and yet it is the least understood subject. You can purchase the highest quality security camera or DVR, but if the video signal is not transmitted by the proper media/ cable, the result will affect the entire solution. Most of the common video signal problems with picture quality can be fixed by selecting the proper cable in advance and following proper installation

## Coaxial Cable Types

Most Security camera video signals are transmitted using coaxial cable. Coaxial cable is designed to transmit the complete video frequency range with minimum distortion or attenuation, making it an excellent choice for CCTV application. However, there are number of coaxial cable to choose from, and choosing the incorrect coaxial cable can degrade the overall signal transmission quality.

## RG-59 CCTV CABLE

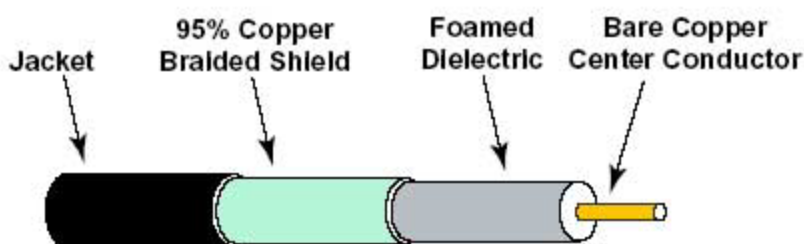

There are various types for coaxial cable. Understanding the various type of coaxial cable and selecting the right cable for a security camera, CCTV system will eliminate video quality problems, money, and aggravation. A security camera video signal is comprised of both low frequency and high frequency components. Selecting the right cable for the job will eliminate distortion or attenuation.

### Positioning of cameras:

Most common installation of CCTV surveillance cameras want to make the camera position as discreet as possible. The bullet security camera is no bigger than your finger in length and can easily be located anywhere. This location also provides good shelter from wind and rain and can be shaded from excessive sunlight. The height of the camera position will give a good area of view and minimize the risk of vandalism.

However, another advantage of this location is cabling. It is usually easy to run the cables into the loft from this position. Many houses have a small ventilation gap between the roof tiles and the external wall, or a small hole may be drilled in the fascia board to gain access to the loft.

---

**Cabling:**

The most common type of cable used in surveillance system applications is the Siamese cable. This cable constitutes two cables glued together for easy cable installation. Each security camera in CCTV installation requires a pair of cable to power the camera and a video cable to send the video signal from the security camera to the security DVR. The Siamese cable include a pair of 18/2 power cable and RG-59 glued together, so you only need to run one Siamese cable to each camera that will provide the video and the power to the camera. At the Security DVR side the RG-59 will be terminated by BNC connector and will connected to the DVR, and the 18/2 power cable will be connected to the power supply to the loft.



If you do not understand any of the CCTV terms used in this guide please see our [CCTV Glossary](#).